

Optical Inspection

LINOS Machine Vision Lenses,
OPTEM Fusion and mag.x Microscope Systems



About Excelitas Technologies

Excelitas Technologies® Corp. is a leading industrial technology manufacturer focused on delivering innovative, market-driven photonic solutions to meet the illumination, optical, optronic, sensing, detection and imaging needs of our OEM and end-user customers.

Serving a vast array of applications across biomedical, scientific, semiconductor, industrial manufacturing, safety, security, consumer products, defense and aerospace sectors, Excelitas stands committed to enabling our customers' success in their many various end-markets. Our team consists

of more than 7,500 professionals working across North America, Europe and Asia, to serve customers worldwide.

Connect with Excelitas on Facebook, LinkedIn, Twitter and Instagram, or visit <http://www.excelitas.com> for more information.

Excelitas®, Excelitas Technologies® and LINOS® are registered trademarks of Excelitas Technologies Corp. All other products and services are either trademarks or registered trademarks of their respective owners.

1877



Rodenstock
founded

1898



Spindler & Hoyer
founded

1991



Point Source
founded

1996



LinOS is founded merging together Spindler & Hoyer, Steeg & Reuter, Franke Optik and Gsänger Optoelektronik. LINOS acquires Rodenstock Präzisionsoptik in 2000

2009



Qioptiq acquires Linos and Point Source establishing a new and consolidated brand

2010



Excelitas Technologies Corp. is founded, spinning-off of PerkinElmer Analytical Instrumentation Division which sprung from EG&G founded in 1947

BIOMEDICAL



CONSUMER PRODUCTS



SEMICONDUCTOR

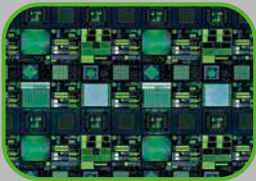

INDUSTRIAL



DEFENSE & AEROSPACE



SCIENTIFIC & ANALYTICAL



Content

Company Profile	02 - 03
Brochure Introduction	04 - 05
LINOS Machine Vision Lenses	
d.fine HR	06
d.fine HR-M	07
inspec.x L 105/120 mm	08 - 09
inspec.x L 5.6/105 VIS-NIR	10 - 11
inspec.x L 4/60	12
inspec.x M	13
MeVis-C	14
MeVis-C/CF Traffic	15
APO-Rodagon	16
Rodagon-F	17
Rodagon, Rodagon-WA	18
Mechanical Accessories	20 - 21
Micro Imaging Solutions	
Optem FUSION Introduction	22 - 23
Optem FUSION Component Overview	24 - 25
Optem FUSION Component Matrix	26 - 27
mag.x 125 Micro-Inspection System	28 - 29
mag.x Component Matrix	30
mag.x Performance and Specifications	31
MachVis Lens Selection Software	32 - 33

2013

2018

2019

2021

2023

2024



Excelitas acquires Qioptiq and Lumen Dynamics

Excelitas acquires Research Electro Optics (REO)

Excelitas acquires Axsun Technologies

Excelitas acquires PCO AG

Excelitas acquires Phoseon Technology

Excelitas acquires Noblelight from Heraeus

Introduction

Our Optical Inspection products cover the broad spectrum from classical Machine Vision to non-industrial imaging with applications in life science, biometrics and direct consumer interaction. All these different applications have their very unique set of requirements that often result in application specific products. With the ever increasing range of different imaging tasks and the enormous diversity of requirements for this multitude of applications it is a huge challenge for manufacturers of inspection components to keep up and offer components that meet the latest requirements. Excelitas with its brands LINOS, OPTEM, and Qioptiq is determined to support as many of these requirements as possible and as a result we constantly add new products to our portfolio.

This brochure provides an overview of our product portfolio and shows the wide range of applications and requirements that is covered with a product offering which spans from traditional LINOS Machine Vision lenses which support large image sensors to super flexible micro imaging solutions with integrated liquid lens focusing and high speed zooming.



mag.x system 125 - modular system for high resolution micro-inspection

The bracket around this product offering is our MachVis software that is available for more than 10 years and proved to be a reliable guide for finding the optimum solution as well as a comprehensive product database in thousands of cases.



Lens selection software MachVis

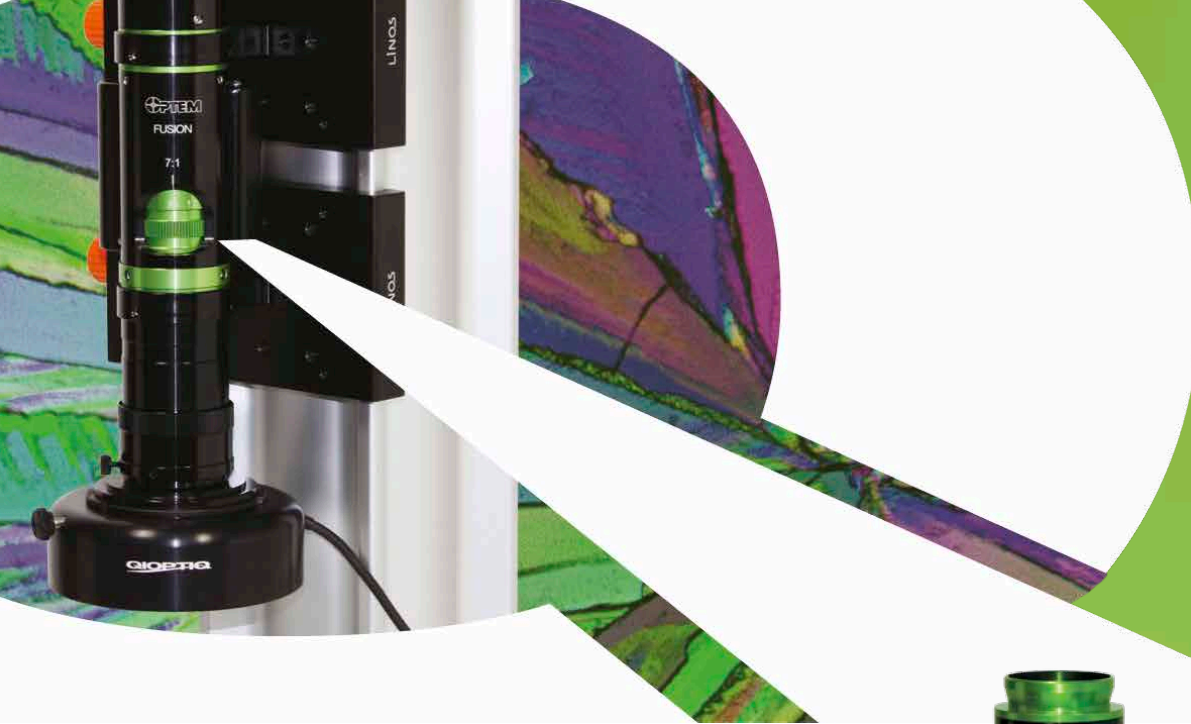

The huge part of the Optical Inspection portfolio that cannot be shown in any brochure is the vast array of customer specific products. From custom variants of standard lenses to fully integrated turnkey sub-modules this collection of specifically designed products is built with the same attention to detail using top notch optical manufacturing technologies and decades of experience in optical and mechanical design as well as patented mounting technologies for performance that matches requirements – not above, not below – just as required.



inspec.x L serie, one of our premium lens programs to meet all conceivable high resolution applications in image processing



Components of the comprehensive OPTEM FUSION system with highest versatility

The basis for custom as well as off-the-shelf products however is a profound understanding of market and application needs. Close collaboration with customers around the world helps us to understand what is really needed and to provide the right solution with the right performance.

A closer look

For further information about our optical inspection systems please scan or click the QR-Code.

d.fine HR Lens

Optimized for a magnification of 3.33X, the d.fine HR 2.4/128 lens delivers unparalleled imaging performance. With modular accessories, the d.fine HR 2.4/128 enables dual-support for both 12k/16k line sensors and large format area sensors, providing the versatility to handle countless imaging tasks. The d.fine HR 2.4/128 is the perfect choice for the most demanding high throughput imaging applications.



- Resolution up to 300 lp/mm (object side)
- For 12k and 16k line sensors and coaxial illumination
- Suitable for large area sensors such as 150 MP
- Optimized for visible spectrum
- Small chromatic focal shift

Application Examples

- FPD
- OLED
- PCB
- Flip Chip
- Semiconductor

- Focal length 128 mm
- Aperture 2.4 ... 8 (design value)
- Numerical aperture 0.13
- Magnification: 3.33 (3.2 ... 3.5)
- Working distance:
 - with prism module 59.9 mm (58 ... 61.4 mm)
 - with area scan module 91 mm (89.2 ... 92.5 mm)
- Spectral range: 400 ... 750 nm
- Distortion < 0.1% (design value)
- Filter threads available

High Resolution Inspection Lens d.fine HR 2.4/128

Product	Focal length (mm)	F-number	Magnification range	Image Circle (mm)	Interface	Part No.
d.fine HR 2.4/128 3.33x*	128	2.4	3.2 ... 3.5	82	V-groove Ø 66 mm	0703-134-000-20

*d.fine HR 2.4/128 3.33x lens must be combined with either d.fine HR prism module or d.fine HR area scan module for proper operation

The d.fine HR 2.4/128 3.33x lens is a perfect match for modern, high resolution cameras supporting 3.5 and 5 µm pixel sensors. In line scan applications, the prism module accessory enables the addition of coaxial illumination alongside high performance imaging. For area scan applications, the compensa-

ting area scan module is compatible with the same lens. Mechanical focusing tubes are readily available to adapt the d.fine HR lens to M72, M90 or M95 camera mounts. The precision-engineered focusing tubes provide fast coarse alignment as well as exact fine tuning of the lens' focal position.

d.fine HR Essential Accessories

Product	Part No.
d.fine HR prism module	0703-130-823-00
d.fine HR area scan module	0703-130-825-00



d.fine HR-M

The new LINOS d.fine HR-M lens series combines the latest technological advancements with a ground up optical design to provide ultra-precision imaging performance across large fields of view. Designed with efficiency and throughput in mind, the large aperture optimizes light throughput to minimize cycle time, which is critical in industrial environments. Ultra fine resolution out to the extreme corners of the field of view ensure consistent imaging performance across full format sensors and long line scan 16K format sensors with pixels sizes down to 3.5µm. In combination with our new flexible focusing and mounting modules, the lens series can be connected to almost any industrial camera, enabling optimal performance for a wide range of machine vision applications.



A closer look

Need more information?

Are you interested, which award this lens series recently won?



7

- Ultra fine resolution lens
- Large aperture maximizing light throughput
- For large area sensors and line sensors up to 16k/3.5µm
- Precision alignment for consistent full field of view imaging performance
- Focal length: 50 and 80 mm
- Aperture 2.6 ... 16
- Image circle: up to 62.4mm
- Working distance: 242 ... 1997mm
- Magnification range: 0.063 ... 0.27
- Spectral range: 400 ... 750 nm

High Resolution Inspection Lens d.fine HR-M 2.8/50 and 80

Product	Focal length (mm)	F-number	Magnification range	Image Circle (mm)	Interface	Part No.
d.fine HR-M 2.6/50 0.15x	50	2.6	0.1 ... 0.2	56.8	V-groove ø44	0703-145-000-20
d.fine HR-M 2.6/50 0.063x	50	2.6	0.025 .. 0.1	56.8	V-groove ø44	0703-145-000-30
d.fine HR-M 2.8/80 0.2x	80	2.8	0.14 .. 0.27	62.4	M52x0.5	0703-146-000-20
d.fine HR-M 2.8/80 0.09x	80	2.8	0.04 .. 0.14	62.4	M52x0.5	0703-146-000-30

inspec.x L 105/120 mm

The inspec.x L Series was developed to meet the highest requirements in industrial image processing with very large sensors. This Lens Series shows even contrast and resolution over an image circle of up to 82 mm. The field-proven performance makes these lenses a perfect match for sensors like the popular 12k/5µm and 16k/5µm line-scan sensors. Very large area-scan sensors also benefit from the high resolution, low distortion and excellent color correction of these lenses.



inspec.x L prism lens with prism module

- Outstanding MTF performance
- Diffraction limited optical design
- Perfect match with 5 µm and useable down to 3.5 µm pixel size
- Full-metal barrel with lockable aperture
- Focal length: 105 mm and 120 mm
- Aperture: 3.5 ... 22
- Spectral range: 400-750 nm
- Large image circle up to 82 mm
- Camera mount: V-groove / Float 5.6/120: M42

inspec.x L 5.6/105

Product	Focal length (mm)	F-number	Magnification range	Image circle (mm)	Interface	Part No.
inspec.x L 5.6/105 1.0x	105	5.6	0.85 ... 1.2	82	V-groove ø46	0703-082-000-20
inspec.x L 5.6/105 0.76x	105	5.6	0.6 ... 0.9	82	V-groove ø46	0703-083-000-20
inspec.x L 5.6/105 0.5x	105	5.6	0.4 ... 0.65	82	V-groove ø46	0703-084-000-20
inspec.x L 5.6/105 0.33x	105	5.6	0.25 ... 0.45	82	V-groove ø46	0703-085-000-20

inspec.x L float 5.6/105 and 5.6/120

Product	Focal length (mm)	F-number	Magnification range	Image circle (mm)	Interface	Part No.
inspec.x L 5.6/105 float	105	5.6	0.3 ... 3.0	82	V-groove ø46	0703-114-000-20
inspec.x L 5.6/120 float	120	5.6	0.06 ... 0.52	82	M42x0.75	0703-116-000-21

inspec.x L 4/105

Product	Focal length (mm)	F-number	Magnification range	Image circle (mm)	Interface	Part No.
inspec.x L 4.0/105 3.5x	105	4.0	3.3 ... 3.7	82	V-groove ø46	0703-095-000-21
inspec.x L 3.5/105 5.0x	105	3.5	4.8 ... 5.2	82	V-groove ø46	0703-102-000-20
inspec.x L 4.0/105 3.5x prism	105	4.0	3.3 ... 4.0	82	V-groove ø46	0703-107-000-20
inspec.x L 3.5/105 5.0x prism	105	3.5	4.8 ... 5.2	82	V-groove ø46	0703-108-000-20

Prism module

The prism module is designed for the following lenses:

- inspec.x L 4/105 3.5x prism
- inspec.x L 3.5/105 5x prism

Product	Part No.
Prism module	0703-107-824-00

Some example applications are:

- PCB inspection
- Display inspection
- Film and slide digitization
- High-end book scanning
- Glass inspection
- High-resolution web inspection
- 3D imaging

A closer look

For further information
about our Lens
Selection Software
MachVis, please scan
or click the QR-Code.

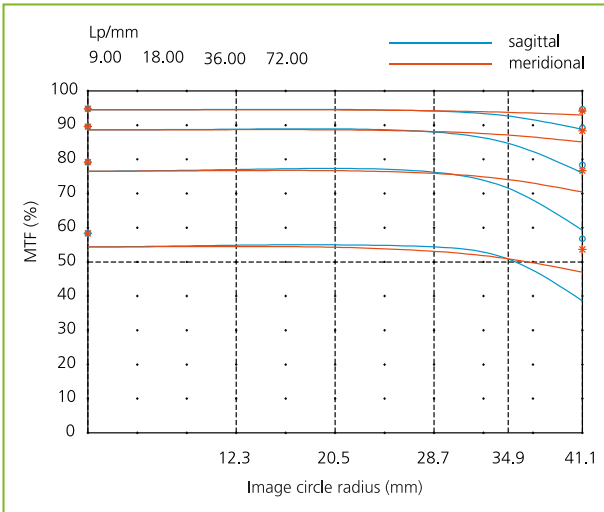

MTF of inspect.x L 5.6/105 0.5x @ $\beta' = -0.5$ and f-stop = 5.6

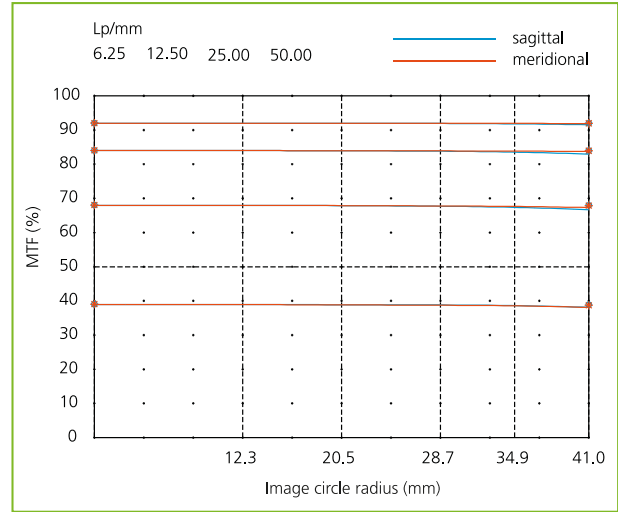

MTF of inspect.x L 4.0/105 3.5x @ $\beta' = -3.5$ and f-stop = 4

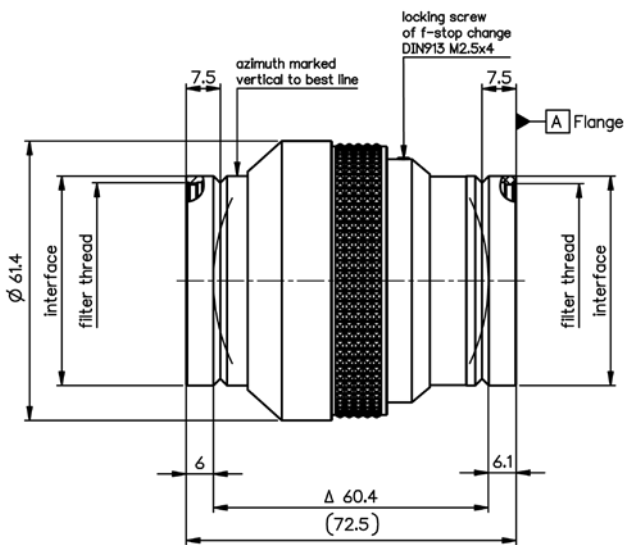

inspect.x L 5.6/105 0.5x

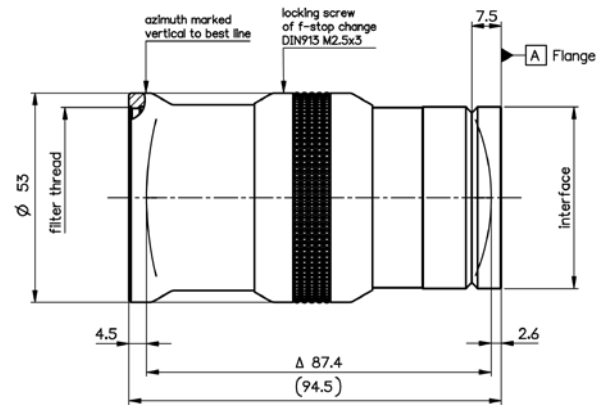

inspect.x L 4.0/105 3.5x

NEW

inspec.x L 5.6/105 VIS-NIR

The inspec.x L VIS-NIR lens series from Excelitas sets a new benchmark in both visual and non-visual inspection. Engineered for long line and large area sensors, it boasts an exceptional apochromatic design. This allows for ultra-sharp, high-contrast images across a broad spectrum of wavelengths from 400 to 1150 nm, eliminating the need for refocusing. The diffraction-limited design ensures outstanding performance throughout the entire object field, delivering optimal results even at the edges.



10

The new inspec.x VIS-NIR series includes four distinct lenses, each optimized for specific magnifications and featuring the established V-groove interface. Every lens in this series is compatible with the Excelitas Modular Focus System, offering unparalleled flexibility and modularity.

Some example applications are:

- VIS-NIR scan without refocus
- Apochromatically corrected lens
- Diffraction limited design for superior performance
- Ultra high resolution for large area and line sensors
- Flexible mounting system for almost any image processing camera
- Excellent price performance ratio
- PCB inspection
- Print inspection
- Surface inspection
- Waste inspection
- Battery inspection
- Food inspection
- Spectral range: 400-1150 nm
- Focal length: 105 mm
- Aperture: 5.6 ... 22
- Large image circle of 82 mm
- Camera mount: V-groove

inspec.x L 5.6/105 VIS-NIR

Product	Focal length (mm)	F-number	Magnification range	Image circle (mm)	Interface	Part No.
inspec.x L 5.6/105 VIS-NIR 1.0x	105	5.6	0.85 ... 1.2	82	V-groove ø46	0703-082-000-30
inspec.x L 5.6/105 VIS-NIR 0.76x	105	5.6	0.6 ... 0.9	82	V-groove ø46	0703-083-000-30
inspec.x L 5.6/105 VIS-NIR 0.5x	105	5.6	0.4 ... 0.65	82	V-groove ø46	0703-084-000-30
inspec.x L 5.6/105 VIS-NIR 0.33x	105	5.6	0.25 ... 0.45	82	V-groove ø46	0703-085-000-30

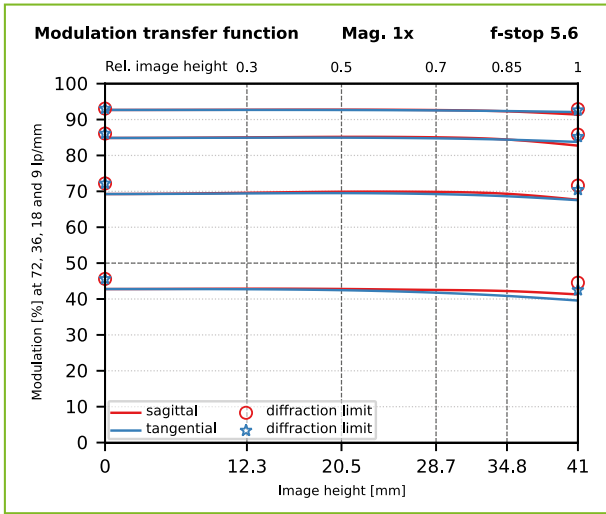

MTF of inspect.x L 5.6/105 VIS-NIR 1x @ $\beta' = -1$ and f-stop = 5.6

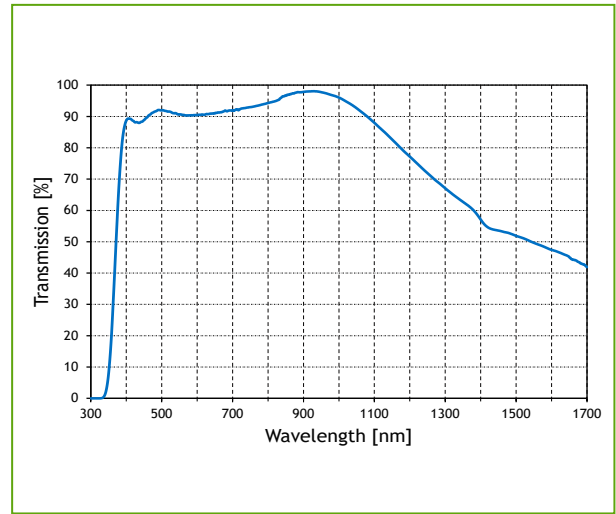

Transmission of inspect.x L 5.6/105 VIS-NIR

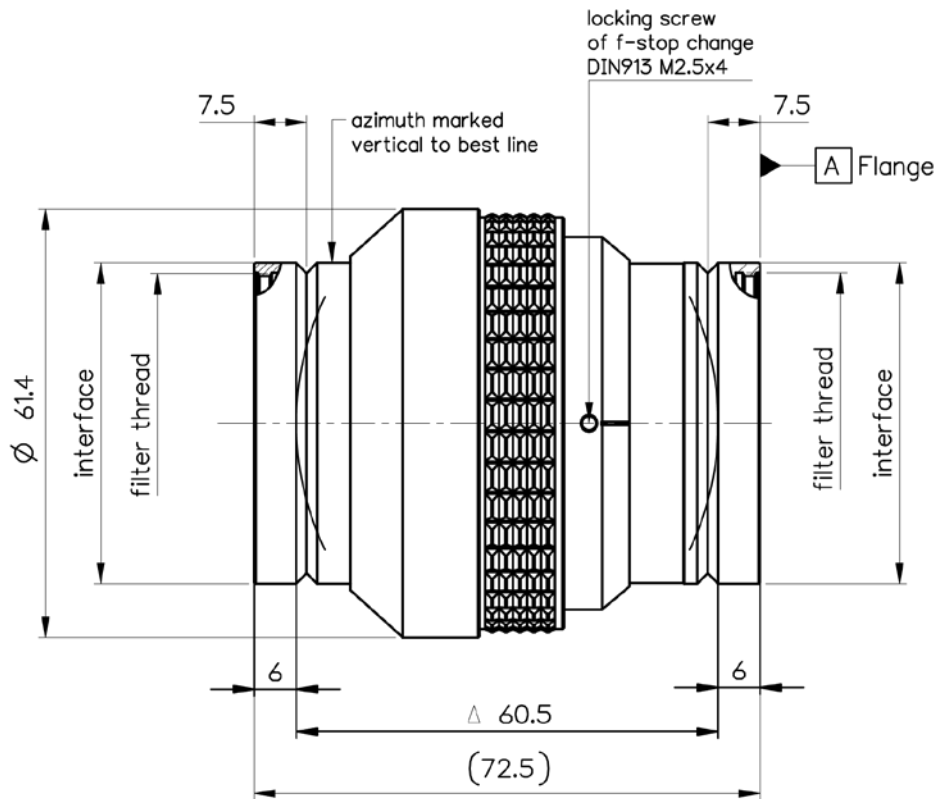

inspec.x L 4/60

The inspec.x L 4/60 is optimized for magnifications from infinity down to around 0.2x. In this range, the lens shows exceptional contrast over a large sensor size of up to 70mm. High contrast goes along with very good color correction and low distortion. The 60mm lens provides unusually high performance for such a short focal length and enables imaging of large objects in space constrained environments with large sensors.



- High contrast for small magnifications
- Excellent color correction
- Focal length: 60 mm
- Magnification range: 0 ... 0.2
- Image circle up to 70 mm
- Spectral range: 400-750 nm
- Iris diaphragm: manual, continuous with set screw
- Mount: compatible to Modular Focus
- Wide range of mechanical accessories

12

The inspec.x L4/60 features a threaded interface for use with the popular Modular Focus helical mount that provides access to virtually all existing cameras via different camera adapters.

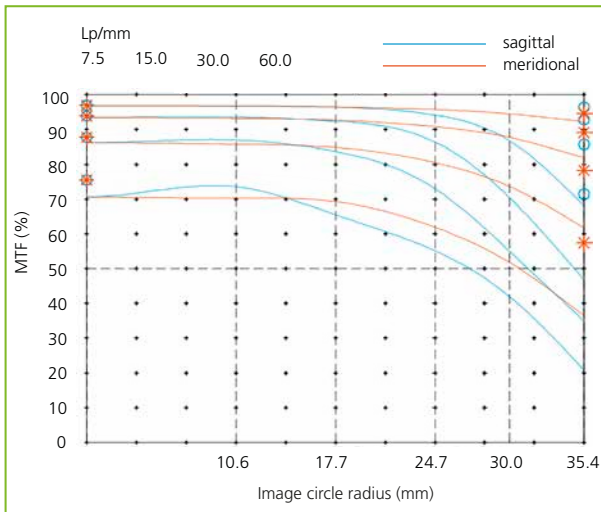

MTF of inspec.x L 4/60 @ $\beta' = -0.03$ and f-stop = 5.6

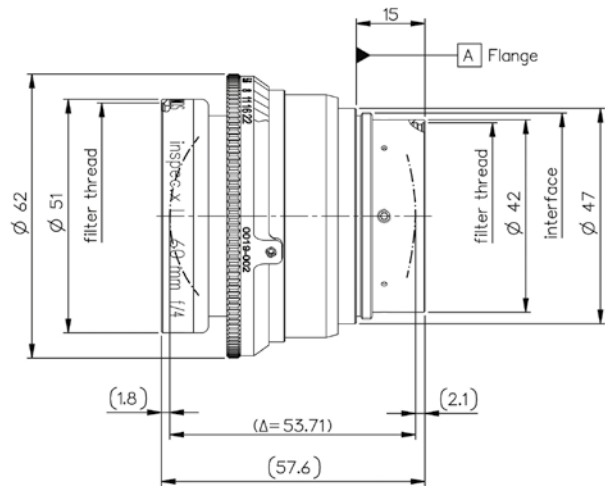

inspec.x L 4/100

inspec.x L 4/60

Product	Focal length (mm)	F-number	Magnification range	Image circle (mm)	Interface	Part No.
inspec.x L 4.0/60	60	4.0	0 ... 0.2	70.8	M45x0.75	0019-002-000-50

inspec.x M

The inspec.x M Series closes the gap between the outstanding C-Mount MeVis-C lenses and the large format inspec.x L lenses.

Equipped with lockable manual focus and manual iris these F-Mount lenses are the ideal choice for sensors up to 35 mm format when a fast f/# is required. The 1.4/50 mm lens is available for visible spectral range or near-infrared. The NIR version lens features a coating for the range from 900 to 1350 nm, making it an ideal choice for applications like electro- and photoluminescence

- Large magnification range
- Very high numerical aperture
- Low distortion

- Optimal magnification: 0.07
- Image circle: 43.3 mm
- Max. sensor size: 35 mm format
- Camera mount: F-Mount
- Focusing: manual, lockable
- Iris diaphragm: manual, lockable

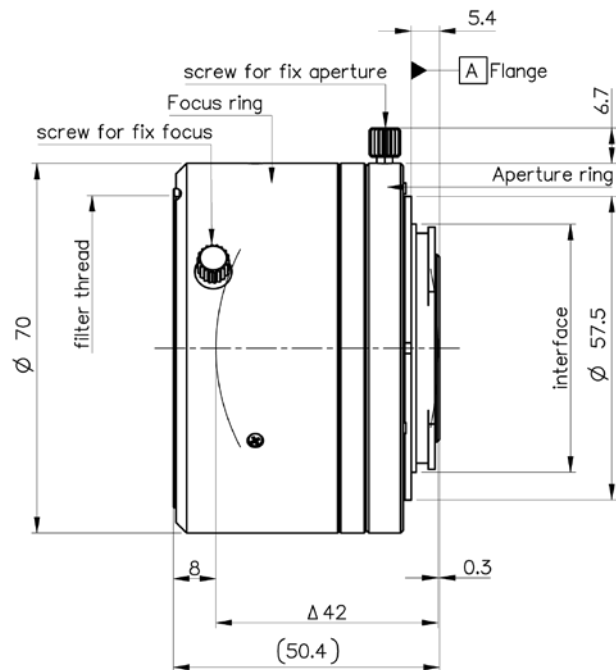

inspec.x M

Product	Focal length (mm)	F-number	Magnification range	Image circle (mm)	Interface	Part No.
inspec.x M 1.4/50	50	1.4	0 ... 0.15	43.3	F-Mount	0009-243-000-40
inspec.x M NIR 1.4/50	50	1.4	0 ... 0.15	43.3	F-Mount	0009-243-000-42

MeVis-C

The LINOS® MeVis-C lenses are specifically developed to be used with the highest resolution sensors available on the market.

Exceptionally high resolution across the entire sensor ensures optimal performance for the most demanding applications. High resolution is paired with low distortion, minimal light falloff and excellent chromatic correction across the entire spectral range of 450-950 nm.



14

Premium glass and specialized coatings further combine to deliver very good color rendition. These lenses can resolve up to 200 lp/mm, even to the extreme corners of a 1" sensor. The combination of these key features is unique to our MeVis-C and represents the perfect match for modern high-resolution sensors with up to 1" diameter.

- Highest optical performance
- Large image circle up to 1 inch
- For pixel size even below 2 µm
- High numerical aperture

- Focal length: 25 ... 50 mm
- Magnification range: 0 ... 0.1
- Spectral range: 450-950 nm
- Focusing: manual, lockable
- Iris diaphragm: manual, lockable
- Filter thread: M35.5x0.5
- Lens diameter: 42 mm

Application Examples

- Pharmaceutical package control
- Rail and wheel inspection
- 3-D measurement
- Solar cell inspection – visible and NIR
- Inspection of contact lenses
- Wood inspection
- Forensics

MeVis-C

Product	Focal length (mm)	F-number	Magnification range	Image circle (mm)	Interface	Part No.
MeVis-C 1.6/25	25	1.6	0 ... 0.1	16	C-Mount	0020-002-000-40
MeVis-C 1.6/35	35	1.6	0 ... 0.1	16	C-Mount	0020-001-000-40
MeVis-C 1.8/50	50	1.8	0 ... 0.075	16	C-Mount	0020-003-000-40

MeVis-C/CF Traffic

The LINOS® MeVis-C/CF-mount traffic lenses feature optimized color correction to eliminate focus-shift between daylight and NIR illumination at approximately 850 nm. This optimized optical design eliminates the need for refocusing when switching between wavelengths as the focal plane for both illumination instances is identical. The field-proven and well-known mechanics of the MeVis-C and MeVis-CF lenses remain unchanged to ensure a robust lens ready for the most demanding industrial applications.



- Optimized for visual spectrum and NIR with identical focus plane over broad wavelength range
- Highest optical performance
- Large image circle up to 1 inch
- For pixel size even below 2 μm
- High numerical aperture

- Spectral range: 450-900 nm
- Focusing: manual, lockable
- Iris diaphragm: manual, lockable
- Filter thread: M35.5x0.5
- Lens diameter: 42 mm

MeVis-C Traffic / MeVis-CF Traffic

Product	Focal length (mm)	F-number	Magnification range	Image circle (mm)	Interface	Part No.
MeVis-C traffic 1.6/25	25	1.6	0 ... 0.1	16	C-Mount	0020-002-000-45
MeVis-CF traffic 1.6/25	25	1.6	0 ... 0.1	16	C-Mount	0020-007-000-30

Application Examples

- License plate reading (ANPR)
- High-resolution surveillance and recognition
- Multispectral/Hyperspectral imaging
- Document verification

Solution MeVis-C/CF Traffic:

Adapted longitudinal color aberration for zero focus shift at 540 nm and 710 nm.

Performance

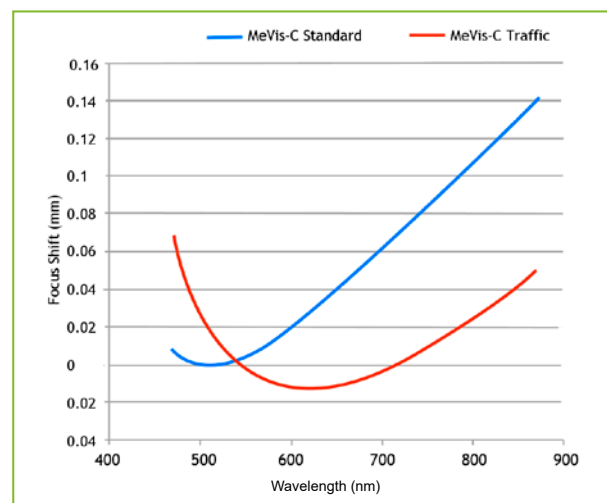

Longitudinal color aberration comparison

APO-Rodagon

The high resolution of the Apo-Rodagon lens series makes them an optimum solution for cameras with a pixel size down to 5 μm . The high resolution is accompanied by ultra-low distortions and negligible color fringing.

Distortion is corrected to near zero and cannot be seen even in critical subjects with straight-lined structures.



Apo-Rodagon-HR 5.6/75 0.5x



Apo-Rodagon-D 4.0/75 1x

- Specially designed for scanning applications and large imaging sensors
- Large image circle up to 102 mm
- Focal length: 50 ... 120 mm
- Magnification range: 0.05 ... 3.0
- Spectral range: 400-750 nm
- Iris diaphragm:
 - HR: fix
 - D / -N: manual, click-stop

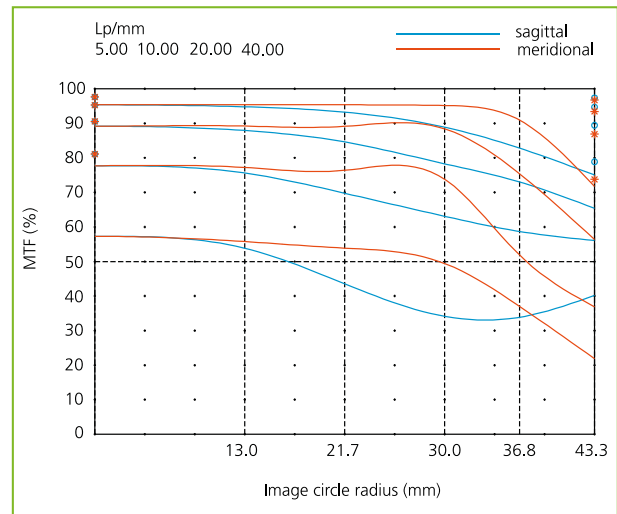

MTF of Apo-Rodagon-D 4.5/75 2x @ $\beta' = -0.5$ and f-stop = 5.6

Apo-Rodagon-HR

Product	Focal length (mm)	F-number	Magnification range	Image circle (mm)	Interface	Part No.
Apo-Rodagon-HR 5.6/75 0.5x	75	5.6	0.35 ... 0.65	62	V-groove $\varnothing 46$	0703-109-000-20
Apo-Rodagon-HR 8/75 0.5x	75	8	0.35 ... 0.65	62	V-groove $\varnothing 46$	0703-109-000-21

Apo-Rodagon-D

Product	Focal length (mm)	F-number	Magnification range	Image circle (mm)	Interface	Part No.
Apo-Rodagon-D 4.0/75 1x	75	4.0	0.8 ... 1.2	82	M39x1/26"	0703-005-000-40
Apo-Rodagon-D 4.5/75 2x	75	4.0	0.4 ... 0.8	86.2	M39x1/26"	0703-101-000-40
Apo-Rodagon-D 5.6/120 2x	120	5.6	0.33 ... 0.8	102	M39x1/26"	0703-043-000-20

Apo-Rodagon-N

Product	Focal length (mm)	F-number	Magnification range	Image circle (mm)	Interface	Part No.
Apo-Rodagon-N 2.8/50	50	2.8	0.05 ... 0.5	44	M39x1/26"	0701-349-000-40
Apo-Rodagon-N 4.0/80	80	4.0	0.067 ... 0.5	86	M39x1/26"	0703-092-000-40
Apo-Rodagon-N 4.0/90	90	4.0	0.066 ... 0.5	90	M39x1/26"	0703-094-000-20
Apo-Rodagon-N 4.0/90 azimuth	90	4.0	0.066 ... 0.5	90	M39x1/26"	0703-094-000-21
Apo-Rodagon-N 4.0/105	105	4.0	0.06 ... 0.5	100	M39x1/26"	0703-096-000-40

Rodagon-F

The Rodagon-F Series is developed to adapt precision industrial-grade optics to an F camera, with a great price/performance ratio. Now, for the first time, users can integrate world renowned Rodenstock image quality in 40-60 mm focal lengths directly onto F-Mount cameras. A revolutionary design eliminates all moving parts to offer exceptionally robust performance. The smooth focusing is locked with a massive retaining ring that is fixed with additional screws.



The Rodagon-F lenses are available in different versions with fixed apertures. The fixed aperture prevents accidental misadjustment of the iris or slowly shifting aperture values due to vibrations. The image circle is large enough for sensors with full format and the popular 41 mm line sensors.

- Integrated manual focussing
- Suitable for line-scan cameras and large imaging sensors
- Large image circle up to 46 mm
- High numerical aperture
- Focal length: 40 ... 60 mm
- Magnification range: 0 ... 0.5
- Spectral range: 400-750 nm
- Iris diaphragm: fix
- Mount: F-Mount
- Filter thread: M40.5x0.5

Rodagon-F

Product	Focal length (mm)	F-number	Magnification range	Image circle (mm)	Interface	Part No.
Rodagon-F 4/40	40	4	0 ... 0.5	44	F-Mount	0703-090-000-25
Rodagon-F 5.6/40	40	5.6	0 ... 0.5	44	F-Mount	0703-090-000-26
Rodagon-F 8/40	40	8	0 ... 0.5	44	F-Mount	0703-090-000-27
Rodagon-F 2.8/50	50	2.8	0 ... 0.5	46	F-Mount	0703-089-000-24
Rodagon-F 4/50	50	4	0 ... 0.5	46	F-Mount	0703-089-000-25
Rodagon-F 5.6/50	50	5.6	0 ... 0.5	46	F-Mount	0703-089-000-26
Rodagon-F 4/60	60	4	0 ... 0.5	44	F-Mount	0703-087-000-25
Rodagon-F 5.6/60	60	5.6	0 ... 0.5	44	F-Mount	0703-087-000-26
Rodagon-F 8/60	60	8	0 ... 0.5	44	F-Mount	0703-087-000-27

Rodagon, Rodagon-WA

The Linos measuring lenses feature the highest resolution, excellent contrast, minimum distortion and color neutrality. They sharply reproduce images all the way to the very edges of the object.



18

- Suitable for line-scan cameras and large imaging sensors
- Large image circle up to 105 mm
- High numerical aperture
- Adapter available for all common camera interfaces
- Focal length: 28 ... 135 mm
- Magnification range: 0.03 ... 0.5
- Spectral range: 400-750 nm
- Iris diaphragm: manual, click-stop
- Filter thread: M40.5x0.5

Rodagon

Product	Focal length (mm)	F-number	Magnification range	Image circle (mm)	Interface	Part No.
Rodagon 2.8/28	28	2.8	0.03 ... 0.2	32	M32x0.5	0701-389-000-20
Rodagon 4.0/35	35	4.0	0.03 ... 0.2	40	M39x1/26"	0701-401-000-40
Rodagon 2.8/50	50	2.8	0.07 ... 0.5	44	M39x1/26"	0701-345-000-40
Rodagon 4.0/60	60	4.0	0.06 ... 0.5	56	M39x1/26"	0701-393-000-40
Rodagon 4.0/80	80	4.0	0.06 ... 0.5	62	M39x1/26"	0701-391-000-40
Rodagon 5.6/105	105	5.6	0.06 ... 0.5	104	M39x1/26"	0701-394-000-40
Rodagon 5.6/135	135	5.6	0.1 ... 0.5	105	M39x1/26"	0701-398-000-40

Rodagon-WA

Product	Focal length (mm)	F-number	Magnification range	Image circle (mm)	Interface	Part No.
Rodagon-WA 4.0/40	40	4.0	0.066 ... 0.25	46	M39x1/26"	0701-399-000-40
Rodagon-WA 4.0/60	60	4.0	0.066 ... 0.25	82	M39x1/26"	0701-276-000-40

Driven by your Application Parameters ...

Do You know about MachVIS? Our MachVis Lens Configurator is designed to help you find the right lens for your machine vision application.

Based upon four key parameters of your application, MachVis will provide the lens solutions that are most suitable to your specification:

- Working distance
- Object size or magnification
- Sensor size
- Camera mount

MachVis specifies all necessary accessories (e.g. focusing units, extension tubes, magnifying objectives, camera mount adapters, objective lenses, etc.) and generates an itemized list of all part numbers with a schematic drawing in the order of assembly.

Datasheet PDFs are also available for detailed analysis, as well as downloadable 3D CAD data with a single click to build into your system drawings as needed.



19

All specifications, along with your own project notes, can be easily saved for archiving and future reference.



MachVis,
now available as
Web-App.
Have a look at page
32 for more details!

Mechanical Accessories

The mechanical accessories are designed to mount the LINOS Machine Vision lenses to almost every camera in industrial environments. The various focus modules work reliably and with high precision. The large selection of lens systems and their modular design enables a multitude of different applications.

Helical Mounts

Product	Part No.
Modular Focus	2408-009-000-42
Smart focus	2408-021-000-43
Smart focus HR-M	2408-021-000-46

Examples of Applications

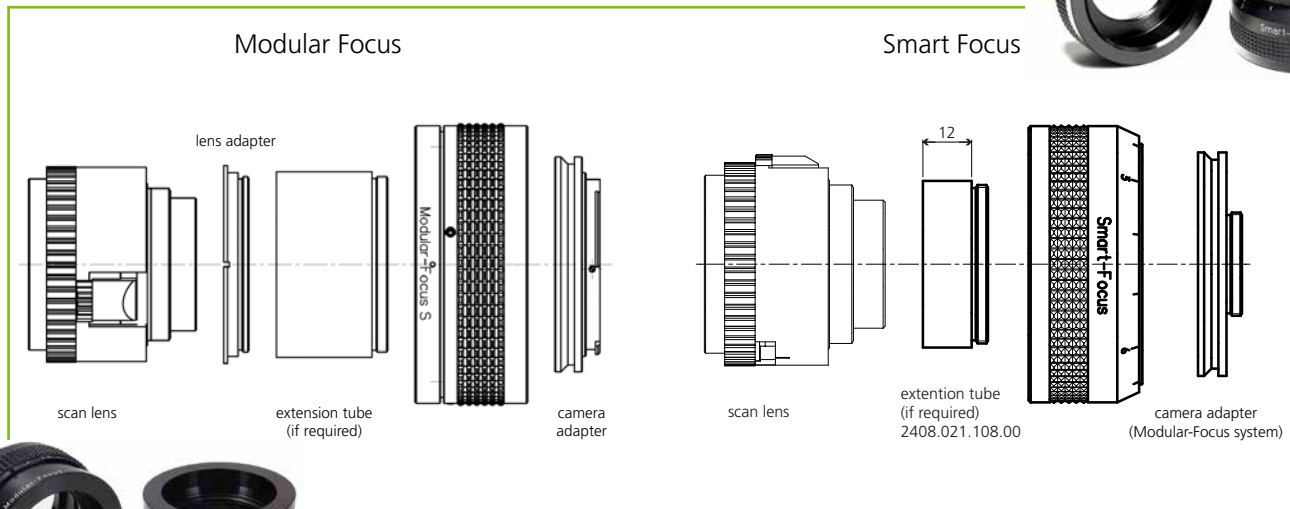

Modular focus

Extension Tubes Modular Focus

Product	Part No.
Extension tube 25 mm M45x0.75	2408-009-113-00
Extension tube 60 mm M45x0.75	2408-009-123-00
Extension tube 87.5 mm M45x0.75	2408-009-122-00

Extension Tubes Smart Focus HR-M

Product	Part No.
Extension tube 15 mm	2408-021-117-00
Extension tube 24 mm	2408-021-118-00
Extension tube 48 mm	2408-021-119-00

Extension Tubes Smart Focus

Product	Part No.
Extension tube 12 mm M39x1/26"	2408-021-108-00
Extension tube 24 mm M39x1/26"	2408-021-109-00
Extension tube 48 mm M39x1/26"	2408-021-110-00
Extension tube 120 mm M39x1/26"	2408-021-111-00

Lens Adapter

Product	Part No.
Lens adapter M32.5x0.5	2408-009-111-00
Lens adapter M39x1/26"	2408-009-118-00
Lens adapter M39x1/26"	2408-009-112-00
Lens adapter M45 - V-groove (ModFoc)	2408-009-147-00
Lens adapter M45 - M42 (ModFoc)	2408-009-173-00
Lens adapter M45 - M52 V-groove	2408-009-176-00
Lens adapter M45 - M52 (ModFoc)	2408-009-177-00

Camera Adapter

Product	Part No.
Camera adapter C-Mount	2408-009-106-00
Camera adapter TFL-Mount	2408-009-174-00
Camera adapter F-Mount	2408-009-142-00
Camera adapter M42x1	2408-009-119-00
Camera adapter M48x0.75 (TFL-II Mount)	2408-009-148-00
Camera adapter M58x0.75	2408-009-132-00
Camera adapter M72x0.75	2408-009-134-00
Camera adapter M90x1.0	2408-009-166-00
Camera adapter M95x1.0	2408-009-155-00

Camera Extension Tubes

Product	Part No.
Extension tube M72x0.75-24mm	2408-009-135-00
Extension tube M90x1.0-24mm	2408-009-167-00
Extension tube M95x1.0-24mm	2408-009-156-00

Retro Rings

Product	Part No.
Retro ring M37x0.75 - M45x0.75	2408-009-152-00
Retro ring M40.5x0.5 - M39x1/26"	2408-009-158-00

Smart and easy

Configure your system
by using our Lens
Selection Software
MachVis. Please scan
or click the QR-Code.



Focus Unit d.fine HR

Product	Part No.
Focus unit HR	2408-025-000-20

Extension Tubes d.fine HR

Product	Part No.
Extension tube 20mm	2408-025-106-00
Extension tube 50mm	2408-025-107-00
Extension tube 100mm	2408-025-108-00
Extension tube 200mm	2408-025-109-00

Camera Adapter d.fine HR

Product	Part No.
Camera adapter d.fine HR M72x0.75	2408-025-111-00
Camera adapter d.fine HR M90x1.0	2408-025-113-00
Camera adapter d.fine HR M95x1.0	2408-025-115-00

Focus Tube inspec.x L 105

Product	Part No.
Focus tube M72 for inspec.x L 105 mm 0.33x and 0.5x	2408-012-000-31
Focus tube M72 for inspec.x L 105 mm 0.76x and 1.0x	2408-012-000-30
Focus tube M72 for inspec.x L 105 mm 3.0x and 3.5x	2408-012-000-47
Focus tube M72 for inspec.x L 105 mm 5.0x	2408-012-000-33
Focus tube M95 for inspec.x L 105 mm 0.33x and 0.5x	2408-012-000-41
Focus tube M95 for inspec.x L 105 mm 0.76x and 1.0x	2408-012-000-43
Focus tube M95 for inspec.x L 105 mm 3.0x and 3.5x	2408-012-000-46
Focus tube M95 for inspec.x L 105 mm 5.0x	2408-012-000-45

Focus Clamp d.fine HR-M

Product	Part No.
Focus Clamp	2408-006-820-00

Extension Tube Focus Clamp

Product	Part No.
Extension tube 7.5mm	2408-006-103-00

Adapter Focus Clamp

Product	Part No.
Adapter focus clamp	2408-006-102-00

Optem FUSION

Extreme Micro-Imaging Versatility

The Optem FUSION Lens System incorporates expanded functionality, bi-directional infinity optics, and a uniform modular matrix to provide OEMs with the ideal lens solution for streamlined integration of high-magnification imaging across they key VIS (400-700 nm), NIR (700-1100 nm) and **SWIR (900-1700 nm)** wavelength ranges.

Simply change-out modules to modify the form, function and performance of your Optem FUSION Lens System to meet the exact wavelength range, spatial, functional, mounting and imaging requirements of your system.

OEM-Optimized to Streamline Time-to-Market

A FUSION imaging solution can be designed and configured in minutes... not hours. And FUSION's modular offering of universally interchangeable components means your prototype is in place in days... not months.

Configured to Your Application

Using standard FUSION Lens matrix components, Qioptiq has the optical design prowess and manufacturing expertise to incorporate virtually any optical microscopy feature into your Optem FUSION Lens System. Specialized components and custom-tailored configurations are simple, expedient and cost effective.

40 years of experience

We coalesce 40 years of Optem® Lens manufacturing expertise into the perfect fusion of performance, simplicity and flexibility.



Unmatched Modular Imaging Flexibility

- Configure for versatile 7:1 or 12.5:1 zoom optics or for a wide range of economical fixed magnifications
- Plug-n-play system controller ensures seamless integration of motorized zoom, focus and illumination
- NOW, Optem FUSION enables extreme broadband imaging support across the visible and **SWIR** wavebands (400-1700 nm)
- Swap out lower lenses or LWD objectives to configure a wide range of imaging envelopes
- Interchange Camera Mounts and Camera Tubes to optimize sensor coverage for virtually any camera format or mount
- Integrate coaxial or ringlight LED illumination and automate focus and/or zoom with stepper motors
- Incorporate accessories at virtually any point of the lens assembly
- Space-efficient inline multi-point mounts ensure added imaging stability



Camera Mount

Mates FUSION with C, CS, F, EOS, 4/3-mount cameras and more

Camera Tube

Modifies magnification to your camera optimizing chip coverage and performance

Core Optical Module

Determines optical function: Fixed, 7:1 or 12.5:1 zoom magnification - motorized or manual

Lower Function Module

Integrates internal focus - motorized or manual - and coaxial LED illumination options

Lower Lens

Modifies taking magnification to affect field of view, NA and working distance

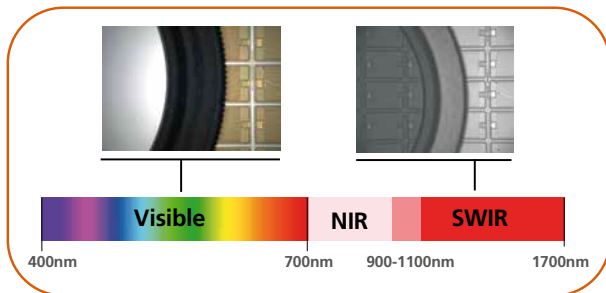

Broad wavelength support makes FUSION the perfect solution for:

- Through silicon defect inspection and alignment
- Hyperspectral imaging
- Fluorescence imaging
- Metrology

FUSION Performance

Fixed Magnification

MINIMUM CONFIGURATION

Magnification.....	0.16X
NA	0.005
Resolution	15.0 lp/mm
Depth-of-Field	23 mm
Field-of-View*	41 x 55 mm
Working Distance.....	490 mm

MAXIMUM CONFIGURATION

Magnification.....	12X
NA	0.18
Resolution	540 lp/mm
Depth-of-Field	0.018 mm
Field-of-View*	0.55 x 0.73 mm
Working Distance.....	32 mm

7:1 Zoom Magnification

MINIMUM CONFIGURATION

	Low Zoom	High Zoom
Magnification	0.067X	0.46X
NA	0.0047	0.016
Resolution (lp/mm)	14 lp/mm	47 lp/mm
Depth-of-Field (mm)	25 mm	2.4 mm
Field-of-View* (mm)	131 x 98 mm	19 x 14 mm
Working Dist. (mm)	490 mm	490 mm

MAXIMUM CONFIGURATION

	Low Zoom	High Zoom
Magnification	5X	35X
NA	0.047	0.16
Resolution (lp/mm)	142 lp/mm	465 lp/mm
Depth-of-Field (mm)	0.25 mm	0.024 mm
Field-of-View* (mm)	1.7 x 1.3 mm	0.25 x 0.19 mm
Working Dist. (mm)	32 mm	32 mm

12.5:1 Zoom Magnification

MINIMUM CONFIGURATION

	Low Zoom	High Zoom
Magnification	0.045X	0.55X
NA	0.0036	0.019
Resolution (lp/mm)	11 lp/mm	58 lp/mm
Depth-of-Field (mm)	44 mm	1.5 mm
Field-of-View* (mm)	196 x 147 mm	16 x 12 mm
Working Dist. (mm)	490 mm	490 mm

MAXIMUM CONFIGURATION

	Low Zoom	High Zoom
Magnification	3.4X	41X
NA	0.036	0.19
Resolution (lp/mm)	108 lp/mm	576 lp/mm
Depth-of-Field (mm)	0.44 mm	0.015 mm
Field-of-View* (mm)	2.6 x 1.9 mm	0.21 x 0.16 mm
Working Dist. (mm)	32 mm	32 mm

* - All field-of-view data calculated for 2/3" camera

FUSION Features

Optem FUSION is engineered to deliver unprecedented configuration and performance flexibility. A wide array of interchangeable components affords OEMs with forward flexibility to evolve imaging capability with the life cycle of their system, and affords researchers with quick swap-out flexibility for benchtop video microscopy applications.



Extreme Imaging Versatility

FUSION delivers three distinct optomechanical capabilities within a single Lens System. Specify economical Fixed Magnification imaging

modules or 7:1 and 12.5:1 Zoom Optical Modules to meet your exact micro-imaging needs. Infinity Optics and uniform fitting components streamline swap-out and maximize flexibility in the development and forward evolution of your system.

24



Optomechanical Flexibility

Integrate 90° Mirror Cubes and 50/50 Cubes at most any point along the optical path to modify the shape and fit of FUSION to your specific integration requirements. Combinations of multiple Cube Modules permit multiple cameras and lens functions to be integrated over a single optical subject.



Achieve Higher Magnification

FUSION is optimized to image through Optem Long-Working Distance Objectives. Select from 2X to 50X in High-Resolution and M-Plan APO and Objectives.

Tunable Lens Module

Space saving liquid lens module allows the integration of autofocus without cumbersome motorized focus drives. Simply inserts directly above the chosen Lower Function Module.





Fluorescence Imaging

Two modules utilizing user supplied Zeiss type 91029 cubes. Lower module provides system fluorescence illumination and imaging. The upper module will allow two different wavelengths to be directed to separate cameras.



Fetura+ High Speed Zoom

Replace the standard 12.5:1 FUSION core zoom module with Fetura+ for increased speed and durability. Fetura+ travels through the entire zoom range in less than 1sec and offers service life in excess of 1-million cycles. Motorization and control is already built in.

25

SWIR Compatibility

When the most detailed information is critical to your application, broad 400-1700 nm wavelength support facilitates multi-modality imaging and is perfect for advanced imaging techniques including hyperspectral imaging and image fusion.

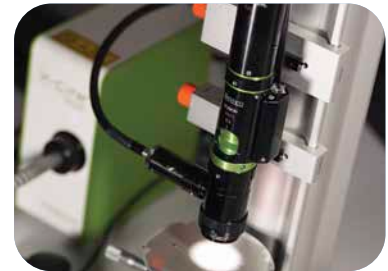

Seamless Motorization

The unified system controller ensures seamless integration of motorized zoom, focus and illumination for high-throughput applications. Featuring an intuitive GUI and feature-rich SDK.

Image Stable Design

Enlarged barrel diameters and wall thickness combine with a 3-point dovetail coupling interface to promote robust lens assembly. Additionally, low profile, Inline Mount Blocks allow multiple mounting points along the assembly length to ensure maximum integration stability.



Optem® FUSION Visible/SWIR Components

ACCESSORIES

35-07-01-000
50/50 CUBE

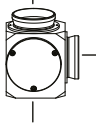

35-07-00-000
MIRROR CUBE

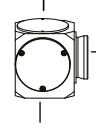

35-07-02-000
MIRROR CUBE ADAPTER

NOTE: 35-07-11 USES 65mm WORKING DISTANCE WHEN USED BELOW LOWER LENS. USE THIS COMBINATION WHEN PLACING RIGHT ANGLE BELOW SYSTEM. REMOVE DOVETAIL TO INCREASE WORKING DISTANCE.

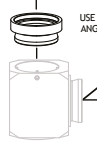

35-07-11-000
INLINE MOUNT



35-07-21-000
25.4MM FILTER HOLDER



35-07-20-000
APERTURE SET



NOTE: NOT EVERY COMBINATION WILL PRESENT DESIRED RESULTS.

35-07-25-000
ADJUSTABLE IRIS



35-07-04-000
FLUORESCENCE CUBE HOLDER UPPER
(NOTE: USES ZEISS TYPE 91029 CUBE)



35-03-50-000
TUNABLE LENS FOCUS MODULE
(NOTE: ATTACH DIRECTLY ABOVE LOWER FUNCTION MODULE ONLY)

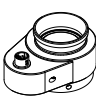

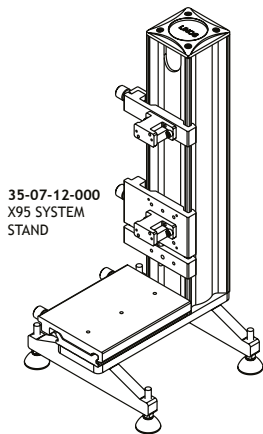

ACCESSORIES

CAMERA



CAMERA MOUNTS

25-60-23-000
EOS CAMERA MOUNT



25-60-24-000
F CAMERA MOUNT



35-08-70-000
C \ CS CAMERA MOUNT



25-60-26-000
4/3 CAMERA MOUNT



CAMERA TUBES

35-08-00-000
CAMERA TUBE
0.4X \ 80 FL



35-08-01-000
CAMERA TUBE
0.5X \ 100 FL



35-08-02-000
CAMERA TUBE
0.6X \ 120 FL



35-08-04-000
CAMERA TUBE
0.8X \ 160 FL

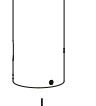

35-08-11-000
MINI CAMERA TUBE
0.8X \ 160 FL



35-08-06-000
CAMERA TUBE
1X \ 200 FL

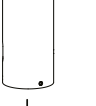

ACCESSORIES

35-07-10-000
CAMERA TUBE CLAMP



35-07-14-000
TUBE CLAMP MOUNT, 76mm dia.

35-07-15-000
TUBE CLAMP MOUNT, 82mm dia.

35-07-16-000
TUBE CLAMP MOUNT, 83mm dia.

35-07-17-000
TUBE CLAMP MOUNT, 84mm dia.

7:1 ZOOM

35-31-10-000
7:1 ZOOM
MANUAL



35-31-40-000
7:1 ZOOM
MANUAL
DETENT



35-31-60-000
7:1 ZOOM
STEPPER
MOTORIZED



FIXED MAGNIFICATION

35-07-20-000
APERTURE SET
REQUIRED FOR FIXED MAGNIFICATION SYSTEMS



NOTE:

- Products listed in **RED TYPE** Indicate **SWIR** version available.
- For ordering purposes, **VISIBLE** components are identified by a "35" prefix, while **SWIR** components use a "45" e.g. 35-XX-XX-XXX **VISIBLE**, and 45-YY-YY-YYY **SWIR**
- All "35-XX" modules are compatible with one another; and all "45-YY" modules are compatible with one another.
- Using "35-XX" and "45-YY" modules with one another is not recommended.
- Non-optics mounts/modules are cross-compatible between **VISIBLE** and **SWIR**

LOWER FUNCTION MODULES

35-03-10-000
15mm FOCUS
MANUAL



35-07-03-000
FLUORESCENT CUBE
HOLDER LOWER



NOTE: USES ZEISS TYPE 91029 CUBE. USE WITH 35-01-00-000 BASIC LOWER FUNCTION MODULE RECOMMENDED.

35-01-00-000
BASIC



ILLUMINATION

LOWER LENSES

35-00-11-000
0.4X \ 500 FL



35-00-10-000
0.5X \ 400 FL



35-00-09-000
0.67X \ 300 FL



35-00-08-000
1X \ 200 FL



35-00-06-000
1.25X \ 160 FL



ent Matrix

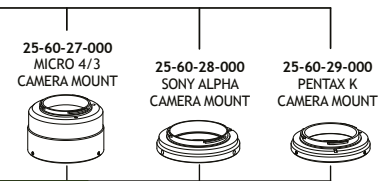

MINI CAMERA TUBES

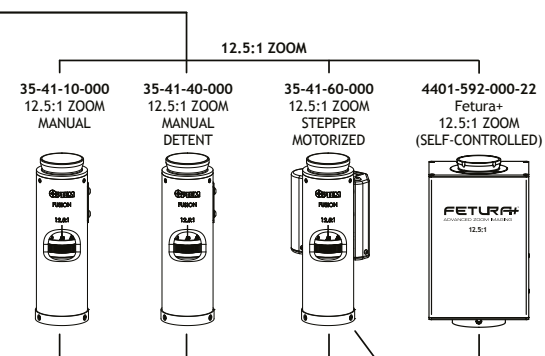
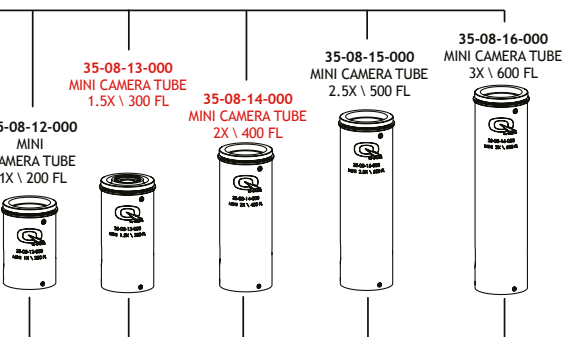

ACCESSORIES

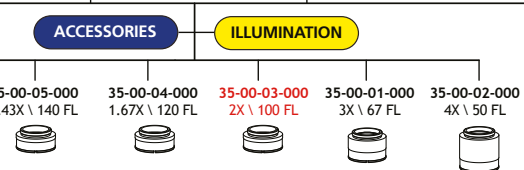
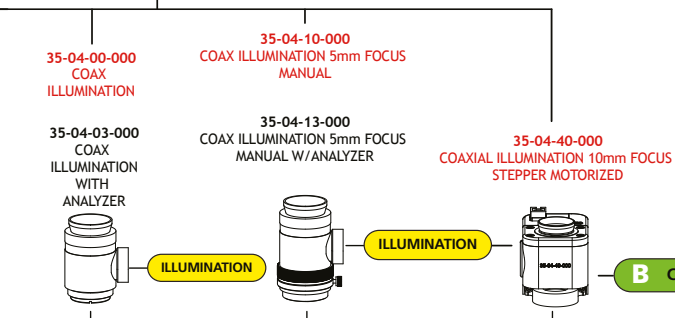

NOTE: COAX ILLUMINATION HAS LIMITED FIELD ILLUMINATION WITH LARGE FOVS.

ILLUMINATION

LIGHTING ACCESSORIES

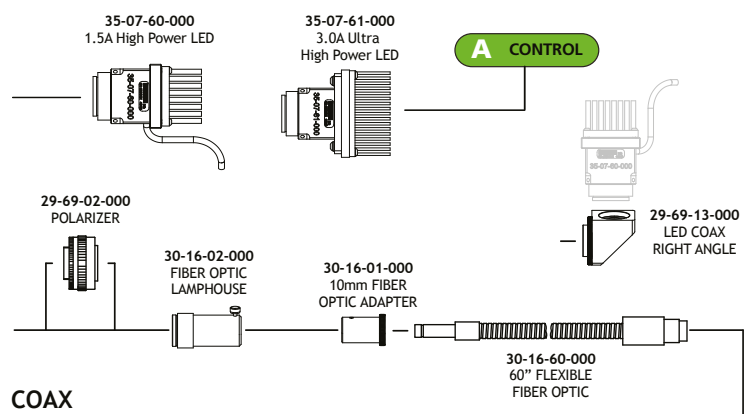

COAX

OBLIQUE

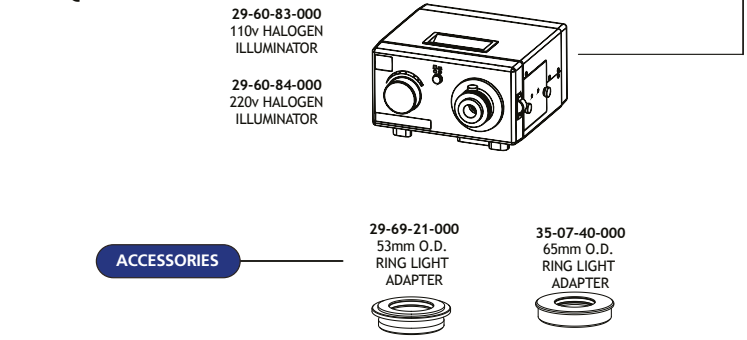

ACCESSORIES

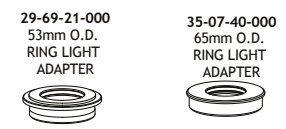

A CONTROL

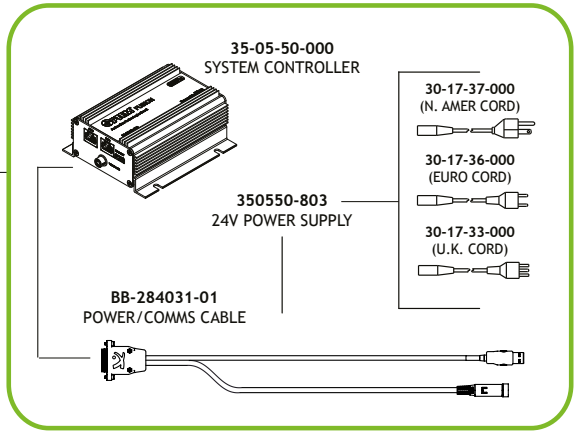

B CONTROL

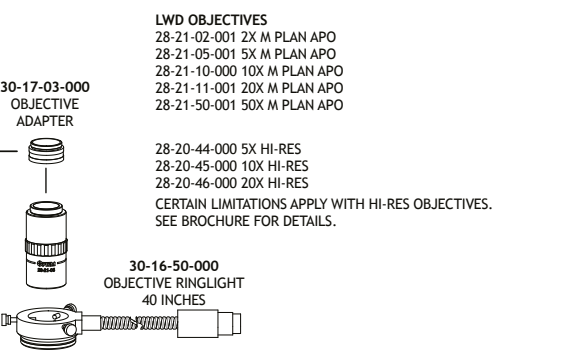

mag.x 125 Micro-Inspection System

Modular System

High resolution inspection is being used in many applications. Each application has its own requirements and constraints. In order to cater for all these diverse needs the mag.x system 125 is as modular as possible. Integration of customized elements is easy and enables a system that integrates seamlessly into the surrounding equipment.

Base units

Heart of the system is always the base unit which is available in different variations. All other components are attached to these base units. Mounting of the system to the surrounding equipment is also provided by the base unit.

Objective lenses

The optical performance of the system is mainly defined by the objective lenses. These are the components that make the mag.x system 125 really unique. All of Qioptiq's highest end technology is being used in manufacturing and testing of these lenses.



Tube lenses

System magnification and maximum sensor size are the result of the combination of tube lens and objective lens. The current selection of tube lenses allows the use of sensors with a diagonal of up to 57 mm. All tube lenses are also telecentric on image side.



Illumination

For coaxial bright field illumination Koehler illumination optics are included that can be interfaced to light sources via optical fibers or directly to LED sources. Darkfield illumination can be added easily with an optional adapter.

Autofocus solution

Focusing in an automated environment is simplified by the mag.x system 125 modular, integrated autofocus solution. Two actuators (Piezo unit respectively motorized z-axis) enable highly-precise focusing in a fraction of a second. The AF base unit couples the laser from an autofocus sensor into the beam path. The autofocus sensor and the actuator constitute a closed-loop system that ensures optimum focus in the object plane. Since no stitching is needed, high-resolution sensors can be used to create significantly shorter tact times without compromising the resolution of the inspection system.

Excelitas/Qioptiq cooperates with WDI Wise Device Inc. - the world's leading manufacturer of industrial autofocus sensors.

Accessories

No system is complete without an array of accessories. The wide selection ranges from camera and fiber adapters to mounting plates. Camera adapters are precisely matched to the camera and tube lens. Various camera adapters can be additionally created on request.

Applications

Numerous applications benefit from the versatility and the high optical performance of the mag.x system 125. The large field-of-view increases throughput of inspection installations as more object space is imaged at once and the number of images that need to be acquired to image an object in its entirety is reduced drastically – in the best case only one image is necessary by maintaining sub- μ resolution.

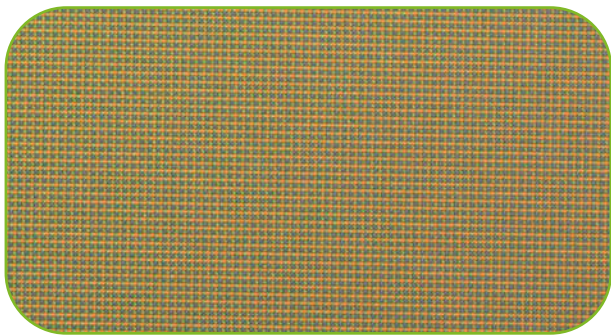

Color CCD sensor with 5.5 μ m pixel size

Typical applications include the inspection of large objects like

- Display panels
- Printed circuit boards
- Glass panels

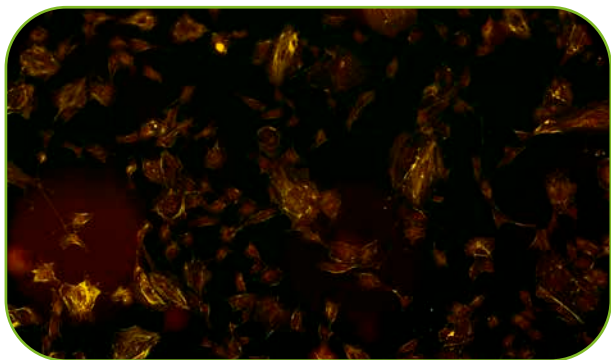

Bovine Pulmonary Artery fluorescence sample

These objects are usually inspected with line scan cameras to achieve maximum resolution and throughput. Smaller objects can often be imaged at once or with only few images with an area scan camera. The 1.73x tube lens is specifically designed for the popular 35mm format cameras that achieve up to 50MPixel resolution. Typical applications are:



- Semiconductor inspection
- Biochip reading
- Fluorescence microscopy
- Digital pathology/histology
- High precision non-contact measurement machines
- Cleanliness of optical components

29

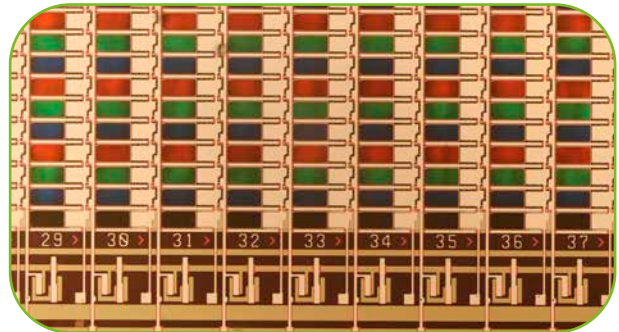

Color TFT display

The optional DIC module expands the applications even more to transparent objects and enables visualization of changes in refractive index or thickness in materials that would not be possible to inspect otherwise.

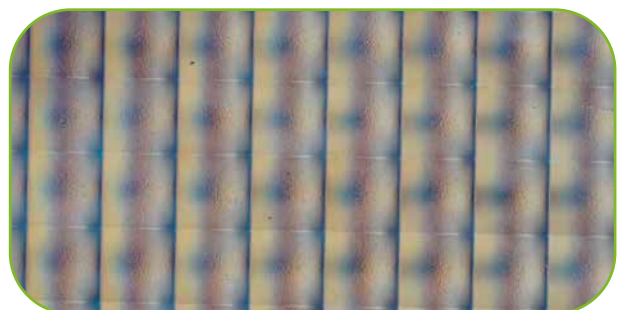

Micro lens array in DIC mode

Overview of the mag.x Micro-Inspection System

Illumination Components:

Just one click to our high performance:

[Liquid Light Guides](#)
and
[Light Sources](#)

30

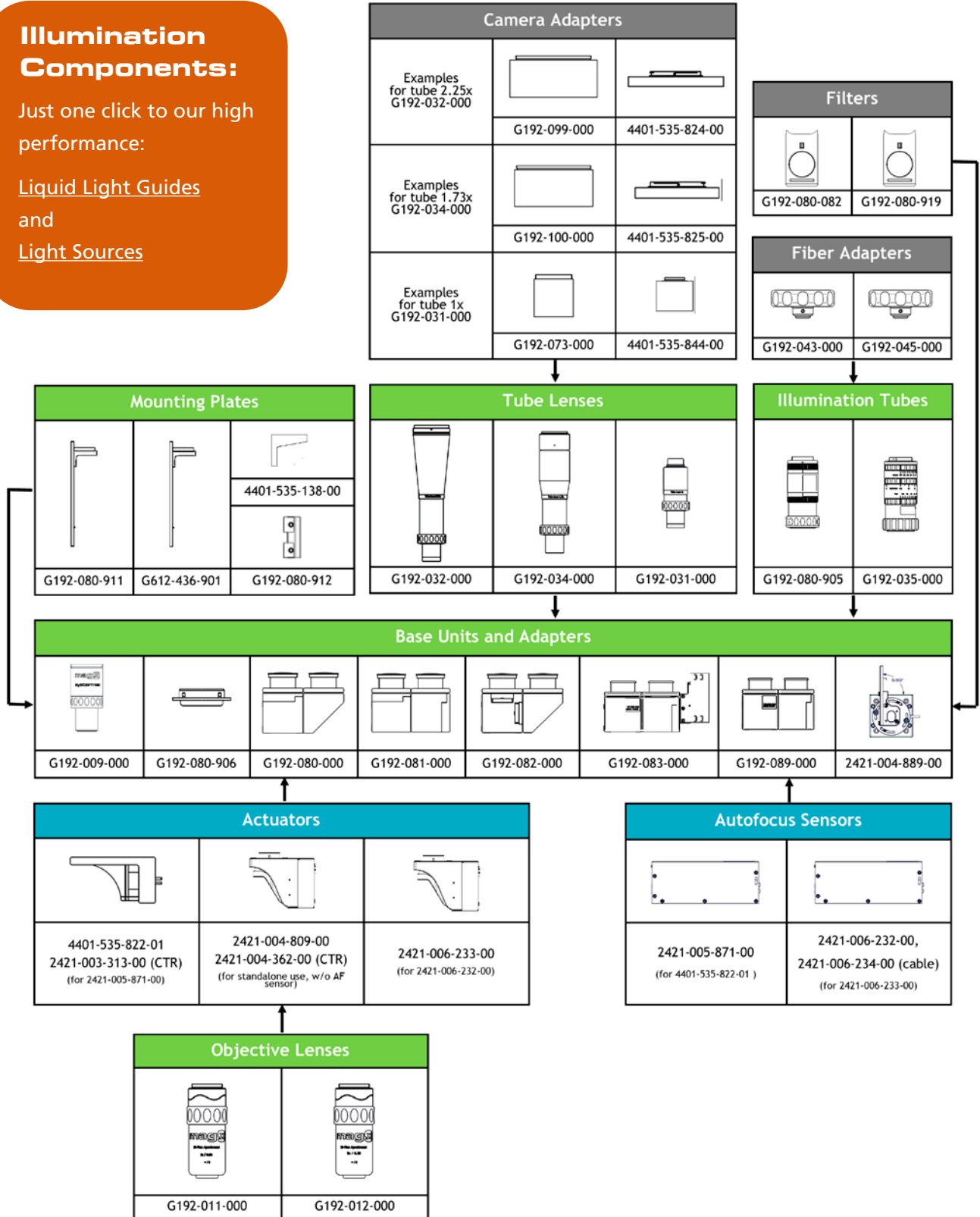

Designed for Large Sensors

The mag.x system 125 is the first microscope system that is specifically designed for the use with large sensors to achieve true wide field imaging with high resolution. With a supported sensor diameter of 57 mm popular line scan sensors like 8k TDI sensors as well as modern super high-resolution array sensors can be used. These sensors fully utilize the high optical bandwidth of the mag.x system 125 that supports up to 50 MPixel sensor resolution.

Optical Performance

Mag.x system 125 stands out from conventional microscope systems by numerical aperture (NA) values considerably higher than those of other systems. High optical quality is not only ensured on the optical axis, but also is maintained over the entire sensor format. The MTF chart below shows the polychromatic MTF versus field height. Values for object y and image heights y' are given under the horizontal axis. Note that the high contrast values close to the diffraction limit are maintained over the entire field!

The complete system is chromatically corrected in the spectral range of 430–700 nm. High contrast is maintained over the entire spectrum and no refocusing is required if the illumination wavelength is changed. Multispectral imaging becomes possible without any additional focus needs.

To enable even the most demanding measurement tasks the mag.x system 125 features precise object space telecentricity to prevent flawed measurements of objects with varying height.

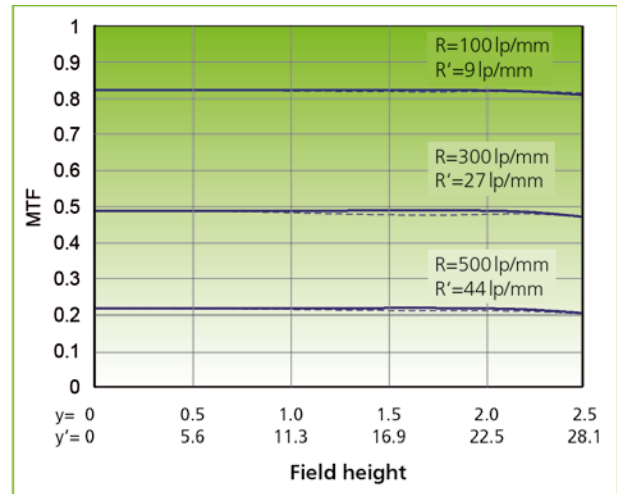

Polychromatic MTF vs. field height
 LD Plan Apo 5x/0.2 + TL2.25x; 2y=5 mm, 2y'=56.3 mm

Specifications

Objective Plan Apochromat					Tube Lens System											
					1x				1.73x				2.25x			
					$f'_{tub} = 250$ mm				$f'_{tub} = 432.5$ mm				$f'_{tub} = 563$ mm			
					$2y' = 25$ mm				$2y' = 43.3$ mm				$2y' = 57$ mm			
Magn./NA	WD	f'_{obj}	δ_{obj}	R_0	2y			R'_0	2y			R'_0	2y			R'_0
	mm	mm	μ m	lp/mm	M	mm	NA'	lp/mm	M	mm	NA'	lp/mm	M	mm	NA'	lp/mm
2x/0.08	24.8	125.0	± 42.7	293	2	12.5	0.04	147	3.5	12.5	0.023	85	4.5	12.5	0.018	65
5x/0.20	13.0	50.0	± 6.8	733	5	5.0	0.04	147	8.7	5.0	0.023	85	11.25	5.0	0.018	65

NA Numerical aperture in the object space = $n \cdot \sin(\sigma)$
 WD Working distance
 f' Focal length of the objective
 f'^{obj} Focal length of the tube lens
 δ_{obj}^{tub} Depth of field at 546 nm $\delta_{obj} = \pm n \cdot \lambda / (2 \cdot NA^2)$

R'_0 Cut off frequency in image space at 546 nm
 R_0 Cut off frequency in object space at 546 nm $R_0 = (2 \cdot NA) / \lambda$
 $2y'$ Image field size (maximum detector diagonal)
 2y Object field size
 M Magnification of the overall system; $M = M_{obj} \cdot M_{tub}$

MachVis Software

Lens Selection and Configurator Software

Excelitas has developed a software tool that simplifies your tasks for imaging and machine vision needs

MachVis is specifically designed to help you identify and select the most suitable lenses and accessories. Your benefit is a high-resolution and stable image on your sensor. With MachVis, Excelitas offers you a software with a user-friendly interface for quick and comprehensive solutions.

Based upon four key parameters of your application,

- Working distance
- Object size (or magnification)
- Sensor size
- Camera mount

MachVis will provide the lens solutions that are most suitable to your specification:

3D files for all optical components as well as mechanical accessories can be downloaded directly from within MachVis for smooth integration into your project with a single click. Configurators are available for the more complex microscope systems for which motorization, zoom modules, beam splitters, filters and numerous illumination options open up a virtually unlimited range of possibilities and flexibility. With these features, MachVis offers a new level of support to make it the most versatile optics configuration software on the market.

In addition to the LINOS[®] Machine Vision Lenses, OPTEM[®] Fusion Micro-imaging System and mag.x[®] 125 microscope system, the PCO[®] Scientific Cameras are also included in MachVis Version 5.3.2 for even more streamlined system configuration.

32

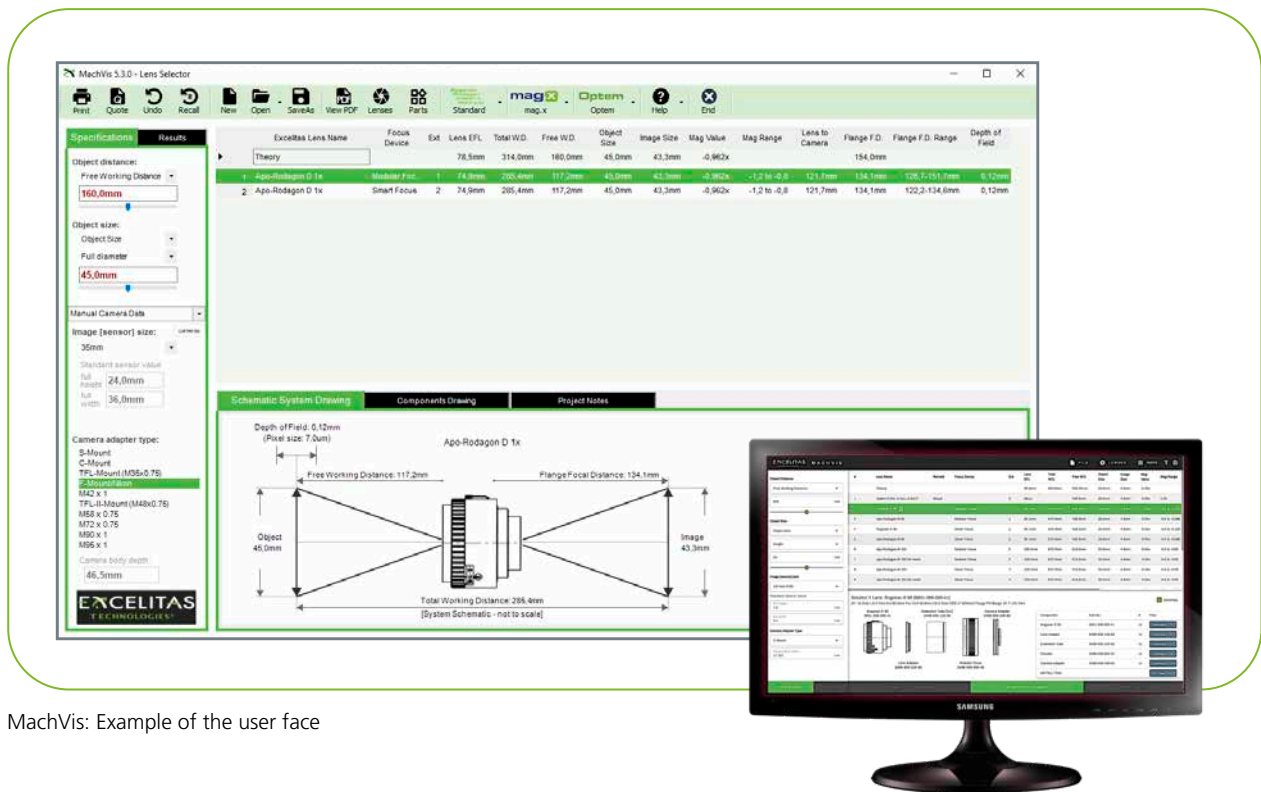

MachVis: Example of the user face

Apart from the geometric optical calculation based on the parameters provided by the user, the software also acts as a product database, providing quick and easy access to all product data and presenting an instant schematic representation of the entire optical system.

With **MachVis Online** it is possible to access MachVis directly without the need to download and install any

software. Let MachVis online convince you and receive more flexibility and independence. MachVis not only helps to identify the perfect lens solution, it saves your time in the lens selection and configuration process.

Try our new online application today and create your own user profile so you can access your individual configurations on any mobile device!



MachVis or
MachVis Online:
Access for FREE!

For further information
about our Lens Selection
Software **MachVis**, please
scan or click the QR-Code.



Object Distance	#	Lens Name	Focus Device	Elit	Lens SFL	Total W.D.	Free W.D.	Object Size	Image Size	Mag. Value	Mag. Change
Free Working Distance		Theory			78.9mm	314.0mm	180.00mm	45.0mm	43.3mm	-0.962x	
100	1	Apo Rodagon D 1x	Module Focus	1	74.9mm	285.1mm	157.2mm	45.0mm	43.3mm	-0.962x	-1.2 M - 0.8
	2	Apo Rodagon D 1x	Smart Focus	2	74.9mm	285.1mm	157.2mm	45.0mm	43.3mm	-0.962x	-1.2 M - 0.8

Solution 1 Lens: Apo Rodagon D 1x [0703-005-000-40]
 [F: 12.9mm LA: 3.7mm Ext: 83.0mm Fluc: 15.8-40.8mm CA: 0.7mm CBD: 45.9mm] Flange F.D. Range: 120.7-151.7mm

Components shown: Apo Rodagon D 1x, Extension Tube [1x], Camera Adapter, Lens Adapter, Module Focus.

MachVis Online: Example of the user face



Discover the Q!

Excelitas serves with Qioptiq a wide variety of applications across the industrial manufacturing sector. With a rich history of delivering innovative photonic components, modules and instruments to integrators, engineers and OEMs, we also offer custom-tailored photonic solutions to maximize the potential and capabilities of tomorrow's many processes and industrial manufacturing systems.

Enabling the future through light.

Europe
+49 (0) 89 255 458 0

North America
+1 (800) 429 0257

Asia/Pacific
+65 64 99 7777

Inspection@excelitas.com
www.qioptiq-shop.com

www.excelitas.com